



**TENNANT BRAND**  
MINDFUL DESIGN

---

## **ASSEMBLY GUIDE**

**Q164-V48/Q169-V48**

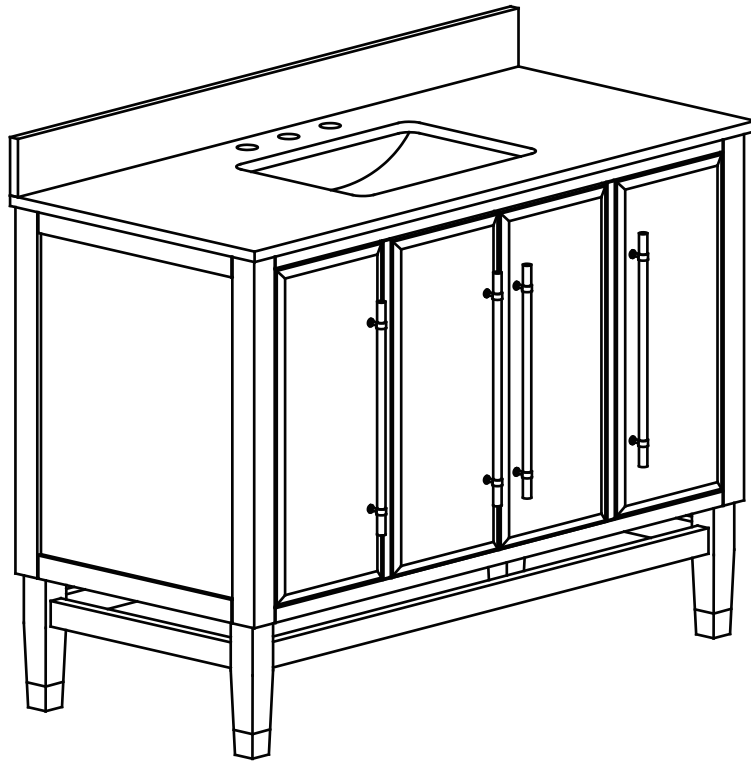

**Questions, Problems, Missing Parts? Before Returning To The Store,  
Call Customer Service  
8 A.M. - 7 P.M., EST, Monday-friday, 9 A.M. To 6 P.M. EST, Saturday**

**1-305-224-1991**

**TENNANTBRAND.COM**

---



## Pre-Assembly (continued)

### HARDWARE INCLUDED



NOTE: Hardware not shown to actual size.



1



2



3



4



5



6



7



8



9

Part	Description	Quantity
1	Bolt (20mm)	12+2
2	Bolt (63mm)	4
3	Gasket	4
4	Gasket	12+2
5	Metal Washer	12+2
6	Nut	4
7	Wood dowel	8
8	Wrench	1
9	Allen key	1

## Pre-Assembly (continued)

### PACKAGE CONTENTS

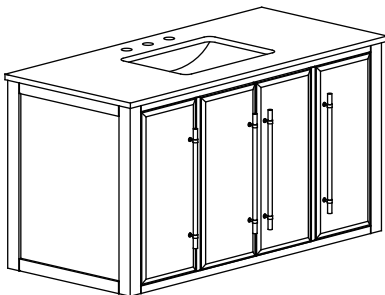

A

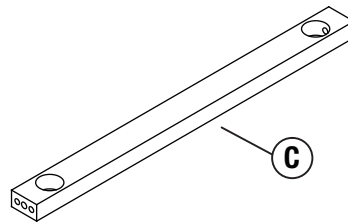

C

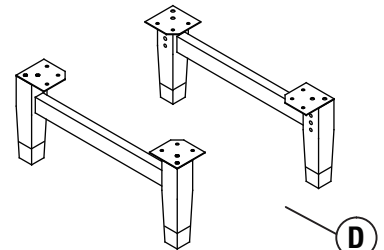

D

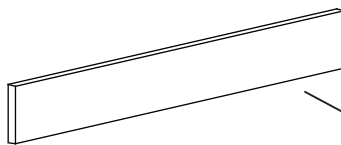

B

Part	Description	Quantity
A	Cabinet body	1
B	Backsplash	1
C	Bottom 1	2
D	Bottom 2	2

# Assembly (continued)

## 1 Installing the bottom and leg

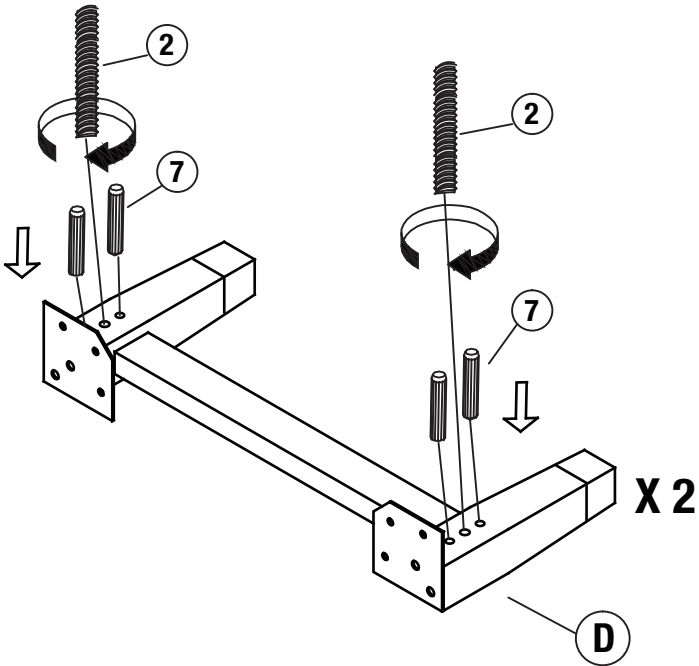

## 2 Installing the bottom and leg

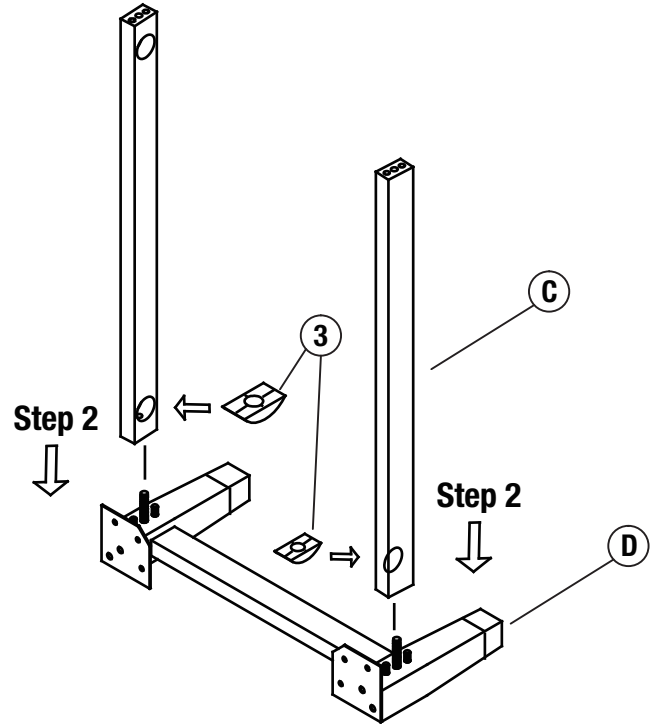

## 3 Installing the bottom and leg

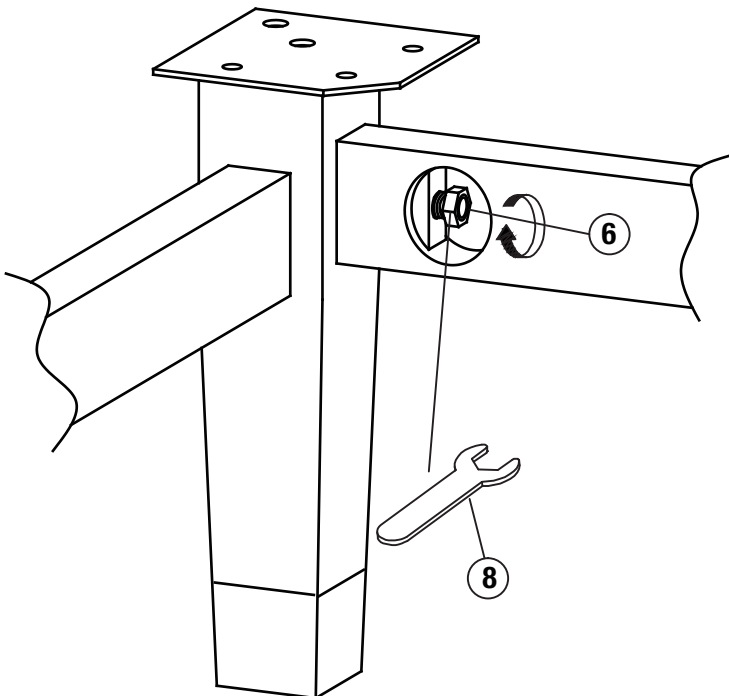

## 4 Installing the bottom and leg

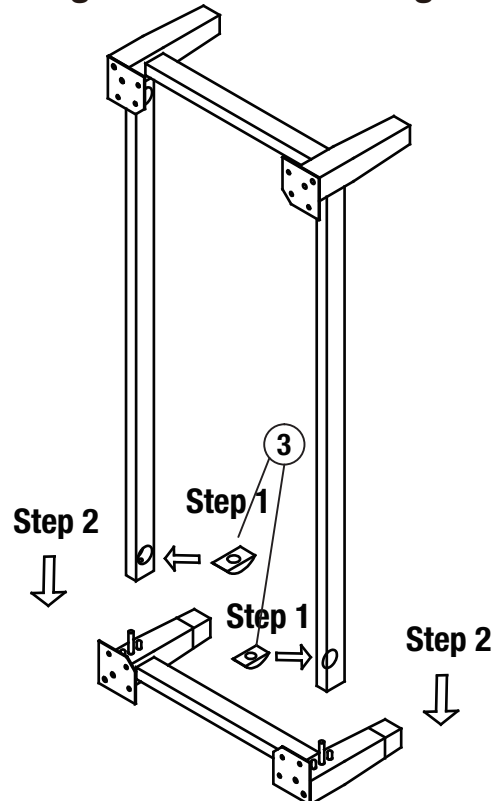

# Assembly (continued)

## 5 Installing the cabinet

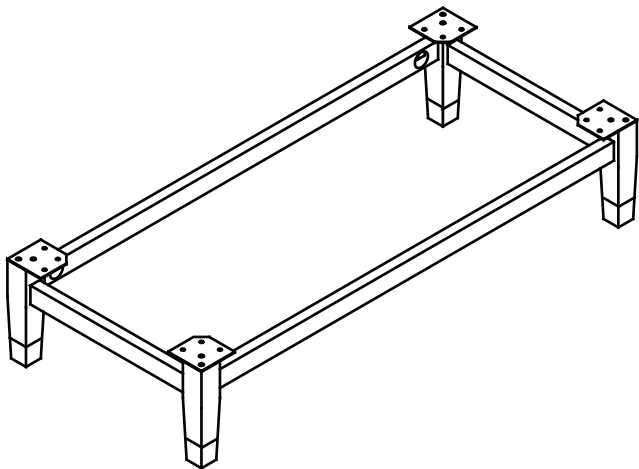

## 6 Installing the cabinet

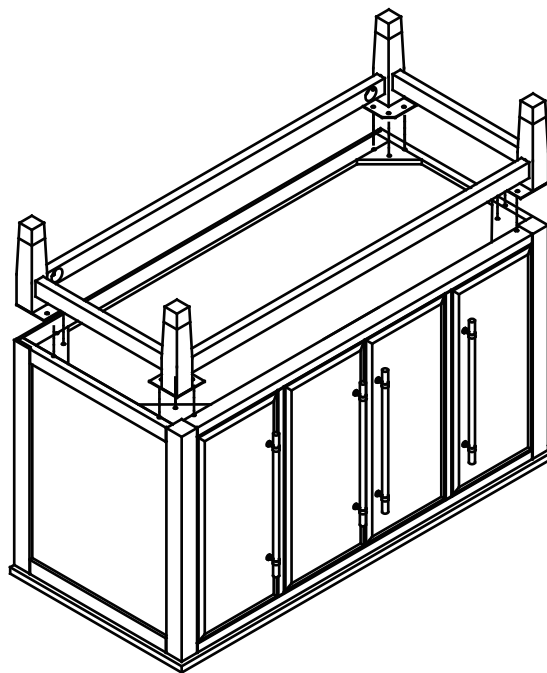

## 7 Installing the cabinet

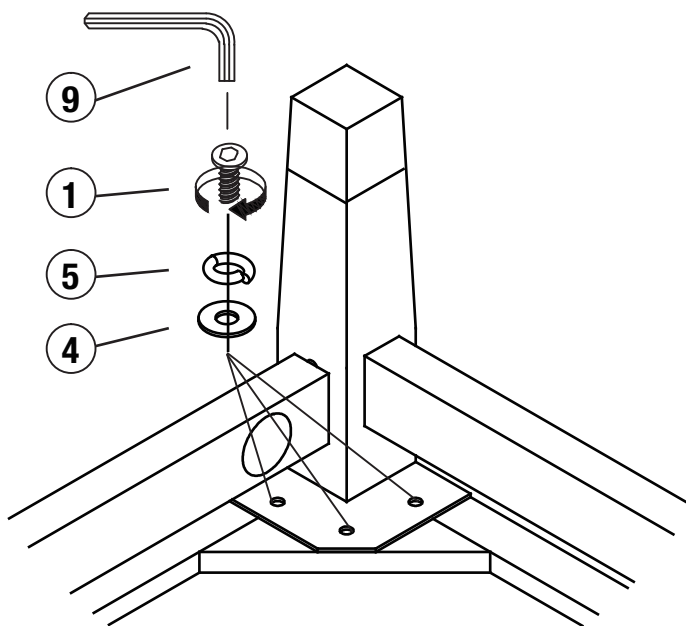

## 8 Installing the cabinet

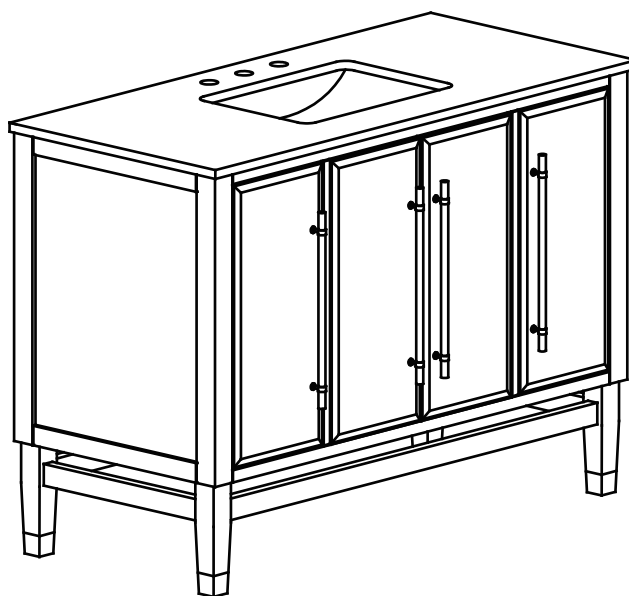

# 9 Installing the BackSpalsh

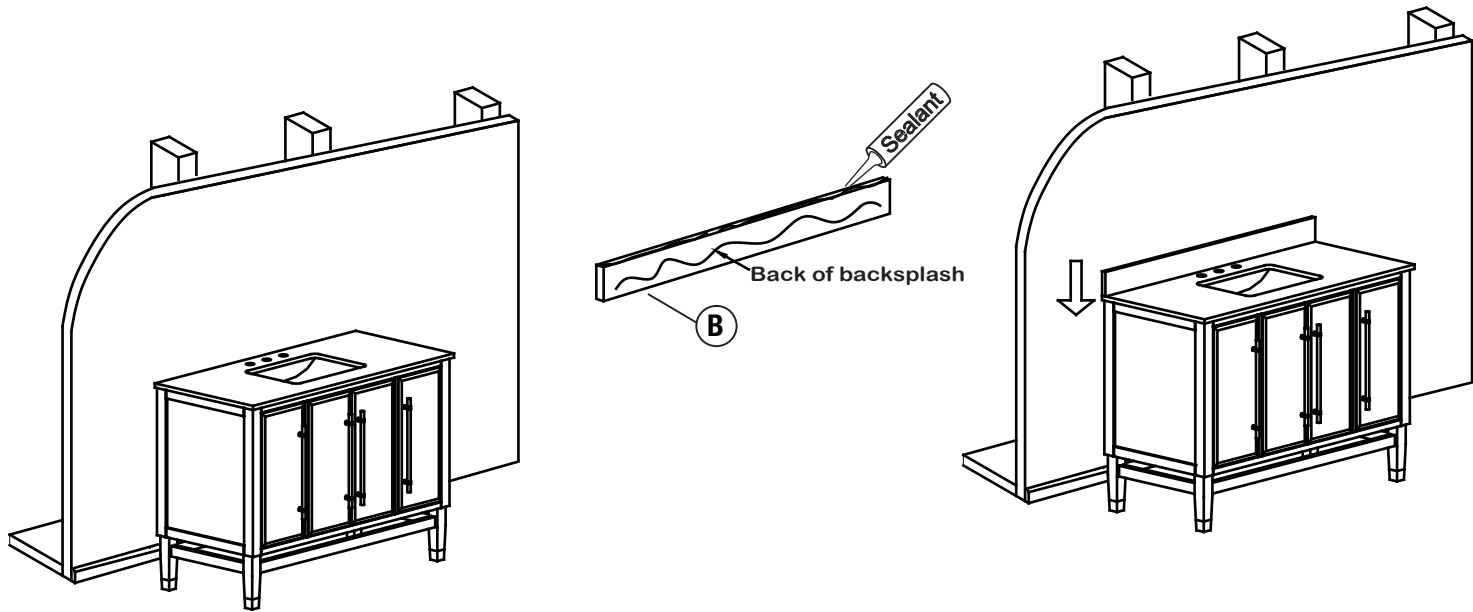



**TENNANT BRAND**  
MINDFUL DESIGN

**Questions, problems, missing parts? Before returning to the store,  
call Customer Service**

**8 a.m. - 7 p.m., EST, Monday-Friday, 9 a.m. - 6 p.m. Saturday**

**1-305-224-1991**

**TENNANTBRAND.COM**

**Retain this manual for future use.**